

Composite dry sliding bushings, metric dimensions

Principal dimensions			Basic load ratings		Mass	Designation
d	D	B	dynamic C	static C0	kg	-
mm			kN			
25	28	40	78	245	0,037	PCM 252840 E

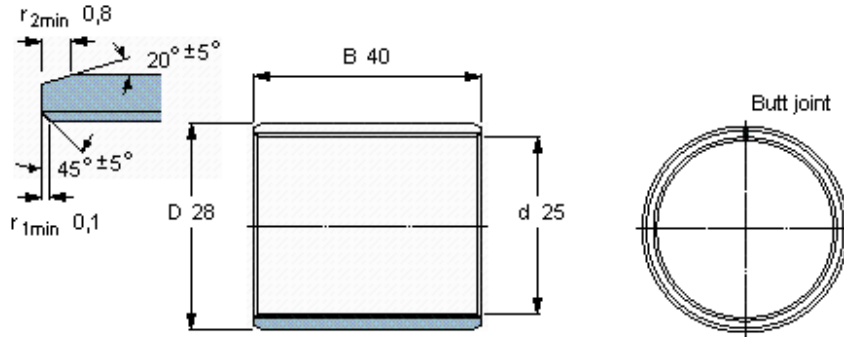

Specific load factor
Material constant

K 80
 K_M 480